



A PERI COMPANY

Propping & Jacking



mabeyhire.co.uk

Welcome to

mabeyhire

Every construction and infrastructure project brings unique challenges. That's where our expertise makes the difference.

Covering the civil infrastructure, buildings and utilities sectors, we've been using our knowledge and experience on projects from bridging and railways to basements and tunneling for over 60 years.

We're the only temporary works specialists in the country that can work with you from early tender stage, design the right solution, supply all the equipment you need, install that equipment and then dismantle it.

All of this, combined with a national engineering team, the UK's widest range of temporary works equipment and a nationwide network of 16 depots, enables us to deliver the right solution for you, whatever the scale or complexity of your project.



What makes Mabey Hire different?

Rapid response

When you need a quick, simple temporary works equipment hire, our network of 16 nationwide depots are ready to deliver or for you to collect.



A complete solution

No other UK temporary works provider can offer a complete in-house solution across design, supply, installation and monitoring for planned, reactive and emergency projects.

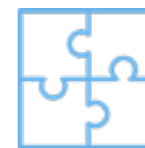

Immersive technology

Explore your design like never before with EVE. Take a virtual walk through your project and identify any changes or potential risks before any work begins on site.



Widest range

We have the UK's widest range of temporary works equipment, including groundworks, propping & jacking, formwork & falsework, temporary bridging & access and monitoring.



All the technical info you need

Instantly access a standard design solution from our standard solutions platform, MyConstruct or find all user guides, Revit families and AutoCAD files on our Tech Hub.



Working across all sectors

We have decades of experience helping our customers build, maintain and repair our country's infrastructure, utilities and buildings.



Taking responsible action

We're committed to protecting the planet, caring for our people and communities, and being a responsible business.



Engineered Solutions

We believe in a world without boundaries. At Mabey Hire, we take our customer's project vision and make it our challenge to engineer the right temporary works solution to bring it to life.

Our large team of qualified and professional engineers, are dedicated to using our creative engineering approach to deliver some of the most exciting construction and infrastructure projects in the country.

For customers who would like us to take away the complexity of managing the enabling stage of multi-phase, multi-partner projects, our expert teams can design, supply and install.

Read on to find out more, or talk to us about your project today on: 0330 191 3562 or email: action@mabeyhire.co.uk.

An engineered solution tailored to your needs

1

Design brief

Our engineering team will work with you to understand the challenges at the critical early stage of the project. This can also include on-site visits from our local field engineers making sure we get the design brief just right, ensuring that the temporary works aspect of a project does not impact any other parties on site.

2

Project Solution

We have the widest range of temporary works equipment, from propping to groundworks, to temporary access and much more. Our engineers have everything to hand to design the complete solution within the constraints of your project.

3

Analysis

Using the latest tools such as 3D Stress Analysis programmes, FEA (Finite Element Analysis) and Soil Interaction software, our experienced, qualified engineers design and check every scheme.

4

Site Liaison & RAMS

Our team work with you to schedule the project and ensure our solution is delivered at the right time, in the right sequence, every time.

5

Site Services

Unique to the temporary works market, we have experienced site teams to install our kit. This unique service reduces project complexity and alleviates risks and delays, and is available across our range of services.

6

Handover

Our experienced engineers will assess the assembly and installation of the scheme, if necessary, detail amendments from the original design and provide a handover certificate.

7

Monitoring

Completing our end-to-end engineered solution for your project, our structural and environmental monitoring solutions, with real-time data help you understand the behaviour of your structure or building environment.

Emergency response

We know that sometimes situations develop quickly, or disaster strikes and you need a fast, efficient response.

In an emergency, our customers can rely on us. As soon as you share your challenge with us, we will work 24/7 to resolve it. For some emergencies this means joining you at the site at any time, day or night.

You can call our emergency response team any time on **03303 119 824**.



Propping & Jacking solutions

As an award winning temporary works specialist, we have over 60 years experience providing customers large and small with solutions to their propping requirements. Whether it's a light propping job, a bridge lift, a façade retention or anything in-between, our wide and versatile range, combined with our engineering teams skills, ensure we can deliver a solution.

We also offer a unique installation and monitoring service. Offering full on-site installation of your propping system and any subsequent monitoring that may be required. We also have the capability to respond to reactive or emergency situations for example, enabling our customers to re-open major roads very quickly after bridge strikes.

Read on to find out more, or talk to us about your project today on: **0330 191 3562** or email: action@mabeyhire.co.uk.



Facade Retention

Our Mass systems have been designed specifically to meet the needs of the Building refurbishment market.



Propping and Shoring

Our large range is perfect for any vertical, horizontal or raking propping and is used extensively in the infrastructure market.



Modular Towers

The versatility of our range allows for a large range of applications within the Civil Engineering sector.

The right propping system for every project

Our Propping Systems have the weight capacity to support low to extremely high load propping applications. Use our load capacity comparison table and chart to ensure you find the right Mabe Hire Propping System for your project.

Low Load (under 100kN)	Medium Load (above 100kN/ under 600kN)	High Load (above 600kN/ under 2000kN)	Extremely High Load (above 2000kN)
Adjustable Props (p8)	System 160 (p14)	Mat 125/Military Trestling (p30)	MU Towers (p38)
Kwikstage (p10)	Mass 10 (p18)	Superprop (p34)	-
Titan Prop (p12)	Mass 25 (p22)	-	-
-	Mass 50 (p26)	-	-

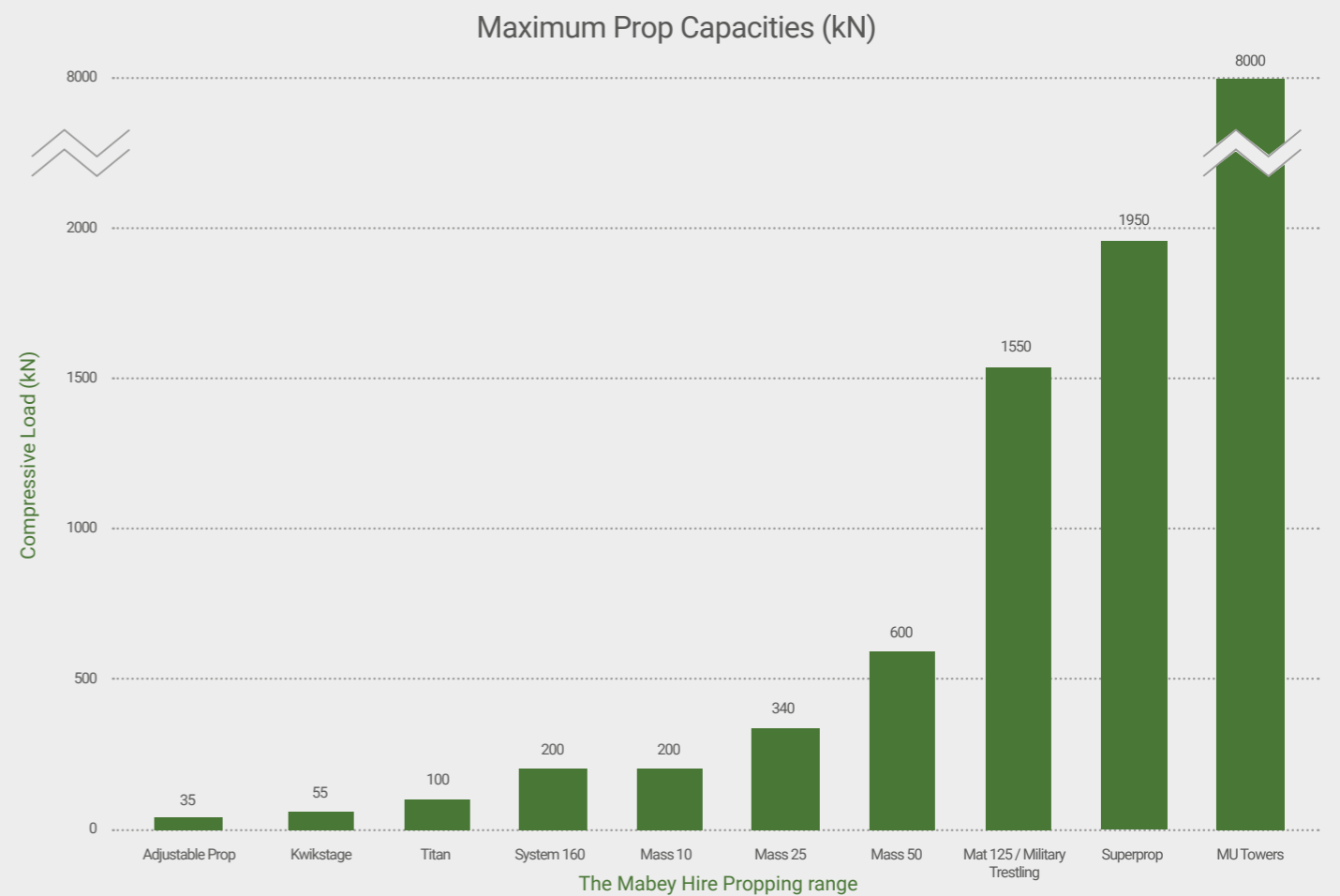

This chart is to be used as a reference guide only and details the maximum loading capacities for each of our Propping systems. For Prop designs please refer to the appropriate Technical Data Sheet available on our website, as capacities vary significantly depending on structural arrangement and load application.

This chart must only be used for indicative selection of the propping system required.

For further information on any of propping and jacking systems please refer to our website at mabeyhire.co.uk

call us on **0330 191 3562** or email action@mabeyhire.co.uk



Adjustable Props

Our range of Adjustable Props are perfect for light duty propping projects. Available in a variety of sizes, they are height adjustable and lightweight, making them versatile, quick to install (with no tools required) and easily handled on site throughout loading and installation.

Designed in accordance with EN1065, these props have a maximum load bearing capacity of 35kN and feature retaining links on the pins and inner tubes for increased safety during installation. Supplied with 150mm x 150mm end plates as standard, these props can also be used with U-heads allowing connection to needle beams.

Configurations:

- Propping

Applications:

- Vertical Propping
- Lightweight Building Propping
- Soffits
- Strongboy Needling

Adjustable Props

Key Benefits:

- Designed in accordance with EN1065
- Height adjustable and lightweight
- Versatile and quick to install
- Lincoln Pin safely secures the load and does not obstruct adjustment
- Self clean threads that clean in both directions
- U-head alternative available, allowing connection to needle beams

Standard Heights and Weights

Size	Closed height (m)	Extended height (m)	Weight (kg)
0	1.07	1.82	14.7
1	1.75	3.12	21
2	1.98	3.35	24.2
3	2.59	3.95	26.3
4	3.2	4.87	30.5

Did you know...
Our adjustable props are fully compatible with strongboys to support brickwork when needing.

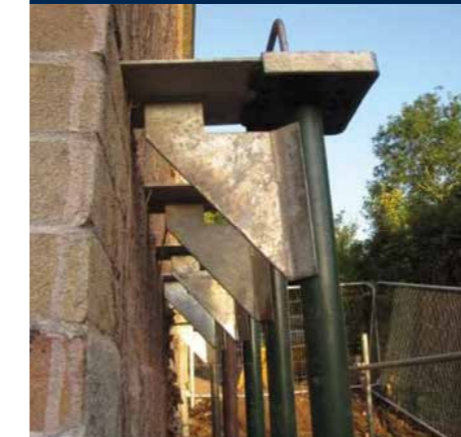

For further information on any of propping and jacking systems please refer to our website at mabeyhire.co.uk

call us on 0330 191 3562 or email action@mabeyhire.co.uk



Kwikstage

Our Kwikstage Shoring is the ideal solution for projects that require a modular brace tower with a maximum axial capacity of 55kN. Featuring both Spigot and Open Ended standards, the modular system is both versatile with minimal tools required for installation, and lightweight, providing ease of use on site.

Our unique V pressings, attached at 495mm vertical centres along the tube, allows shoring ties to be connected easily, ensuring quick assembly of the system.

Configurations:

- Modular Brace Towers

Applications:

- Casting Concrete Soffits, Floors and Roofs
- Falsework
- Access or Shoring

Kwikstage

Components

1. Standards

Fabricated from steel scaffold tube to BS EN 39:2001, there are 2 types of 'Standard' within the Kwikstage system. Our Standards have a spigot at one end, enabling them to be connected end to end and our 'Open Ended Standards' then allow the use of U-heads and Base Jacks at either end. Each type of Standard allows Shoring Ties to be connected quickly and easily with their unique V pressings at regular intervals along the tube.

Standard Length & Weight

End Type	Length (m)	Weight (kg)
Spigot	1.473	7.9
	1.981	12.0
	2.972	17.4
Open Ended	0.991	5.3
	1.473	7.9
	1.981	12.0

Section Properties: BS EN 39:2001 - Steel Tube

Outer Diameter (mm)	Nominal Wall Thickness (mm)	Cross Sectional Area, A (cm ²)	Moment of Inertia, I (cm ⁴)	Radius of Gyration, r (cm ²)
48.3 +/- 0.5	4.0	5.57	13.8	1.57

2. Bracing

The Kwikstage bracing components consist of shoring ties for horizontal bracing, trigger braces providing nodal triangulation of panels and shoring jack braces.

Shoring Ties

Bay Width (B) (m)	Weight (kg)
0.6	4.0
0.9	5.1
1.2	6.9
1.8	9.6

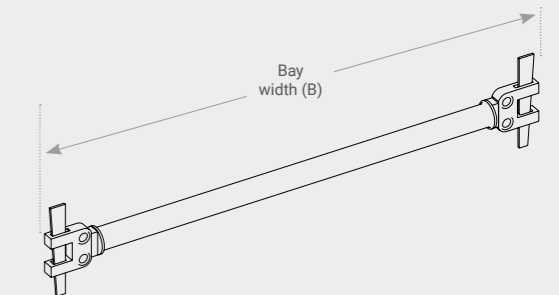

Trigger Braces

Bay Width (B) (m)	Weight (kg)
0.9	1.0
	1.5
1.2	1.0
	1.5
1.8	1.0
	1.5
	2.0

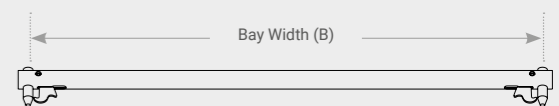

Shoring Jack Brace

Bay Width (B) (m)	Weight (kg)
0.8 - 1.3	5.8
1.118 - 1.929	9.0
1.939 - 2.75	10.5

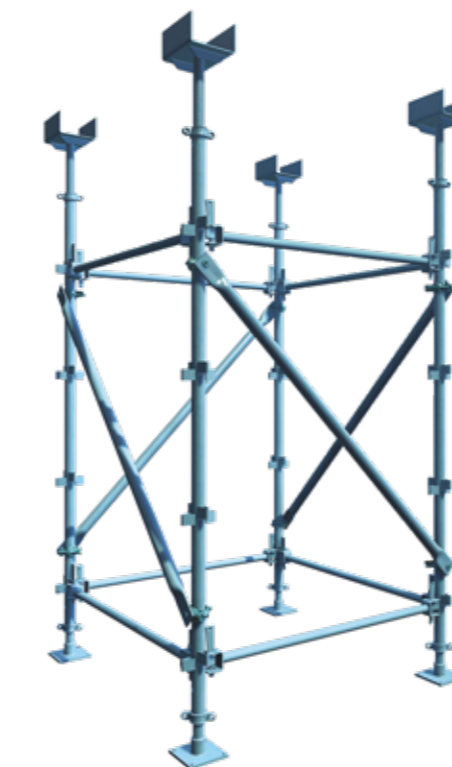

For further information on any of propping and jacking systems please refer to our website at mabeyhire.co.uk

call us on 0330 191 3562 or email action@mabeyhire.co.uk



Titan Prop

Being one of the lightest props on the market, the Ischebeck Titan® prop has an impressive load bearing capacity of 100kN. Made from extruded aluminium and at only 18kg in weight, the prop can easily be lifted without the use of mechanical equipment. With a range of additional ancillary items, the Titan is an ideal solution for many back propping and basement support works, and is compatible with the Needle Beams within both our System 160 and Mass 10 systems.

Configurations:

- Standalone Propping
- Modular Brace Towers

Applications:

- Vertical Propping
- Deadshoring

Titan Prop

Components

Titan Legs and Jacks

Made from extruded aluminium, the Titan leg is available in one basic size, with a working range of 1700mm to 2900mm. It has 4 continuous slots to allow ledger frames and different accessories to be fitted quickly and securely at the optimum height. Titan screw jacks can be fitted at the bottom of each leg, offering vertical adjustment of 1.2m and a 500mm extension is available to increase the height further.

	Length (mm)	Weight (kg)
Size 2 Leg	1700-2900	18.0
500 Leg Ext.	500	4.3
Screw Jack	1600	10.4
Titan Ledger Frame	900	7.5

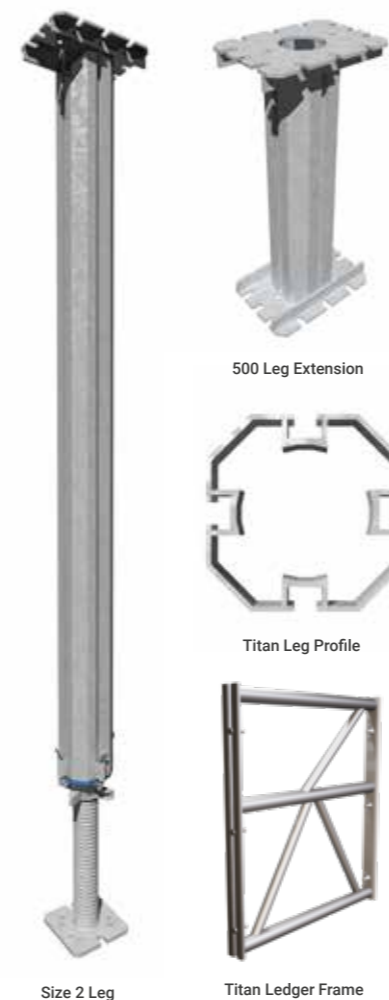

Section Properties

	Cross Sectional Area, A (cm ²)	Moment of Inertia, I (cm ⁴)	Section Modulus, Z (cm ³)	Weight (kg/m)
Extruded Profile	16.275	224	40.7	4.395
Adjustable Jack	15.57	77.0	22.1	10.4

Prop Loading

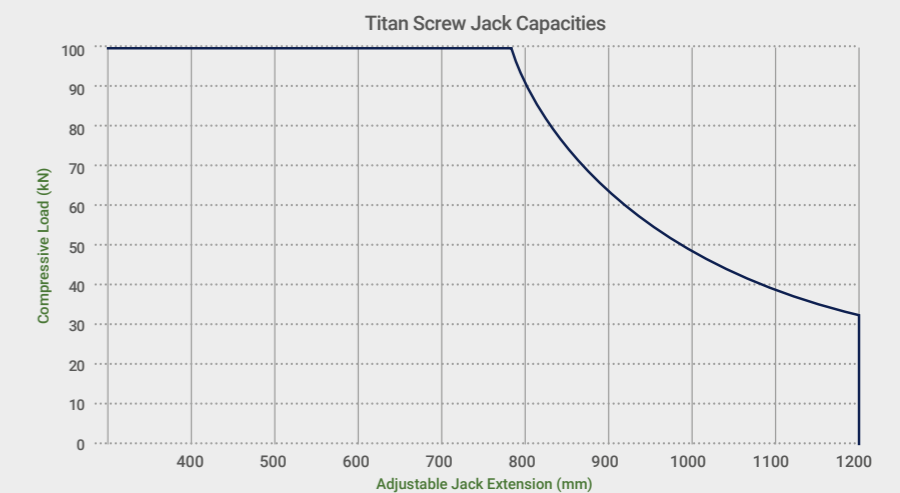
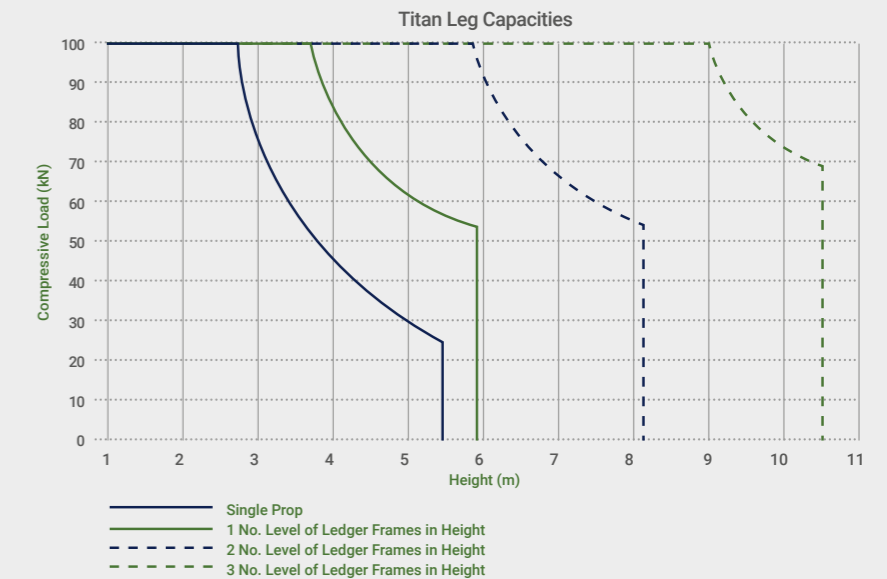

Safe Working Loads

The safe working loads for the Titan equipment have been obtained through testing and calculations based on the safe stresses from BS8118 with a minimum factor of safety of 2.0 applied.

NOTE: In some circumstances, the screw jack will be the limiting factor.

For further information on any of propping and jacking systems please refer to our website at mabeyhire.co.uk

call us on 0330 191 3562 or email action@mabeyhire.co.uk

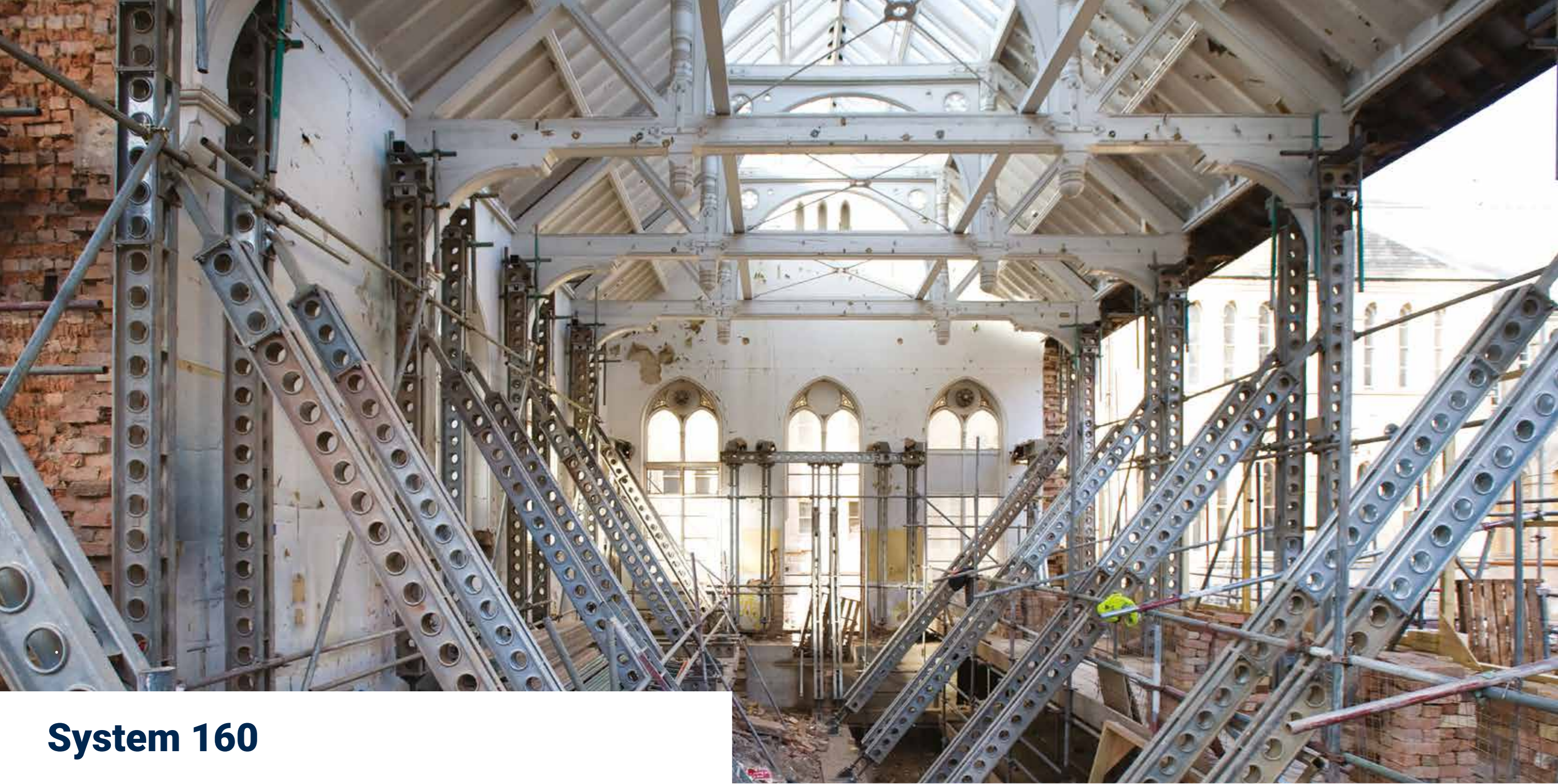

System 160

With a high strength to weight ratio, the unique design of our System 160 creates a compact, high load propping system. Offering a capacity of up to 200kN and a compact 230mm x 180mm prop, the system is lightweight and man-handleable and its clamp connections make it quick to install. The system is ideal for the most demanding formwork and propping jobs.

Configurations:

- Standalone Propping
- Modular Brace Towers
- Primary Beams
- Needlebeams

Applications:

- Vertical Propping
- Horizontal Shoring
- Formwork
- Needling
- Light Façade Retention
- Plan Bracing
- Parapet Replacement



System 160

Components.

1. Props

System 160 prop units form the basis of this system. Fabricated from twin 2.75mm thick back to back cold-formed web and flange sections (Material Grade: HR50 F45), they are provided with 101mm diameter holes in the webs to allow the connection of auxiliary components. The unique design provides high load capacity in a compact 230mm x 180mm prop unit. Components are sized to allow the system to be built by hand within existing structures where required.

Length (mm)	Weight (kg)
360	11.8
540	15.7
900	25
1800	40.0
2340	52
2700	62.5
3600	82



End Elevation

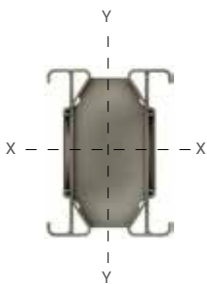

Mid Section

Section Properties

	Area (cm ²)	Moment of Inertia (cm ⁴)		Section Modulus (cm ³)		Radius of Gyration (cm)	
	A	I _{xx}	I _{yy} *	Z _{xx}	Z _{yy}	r _{xx} *	r _{yy} *
Gross	21	1940	189	168	21	8.8	2.7

*Note on Y-Y properties: Performance in the Y-Y direction is relatively complex and values are based on testing and finite element analysis. Refer to Mabey Hire engineers if further information is required.

Prop Loading Capacity

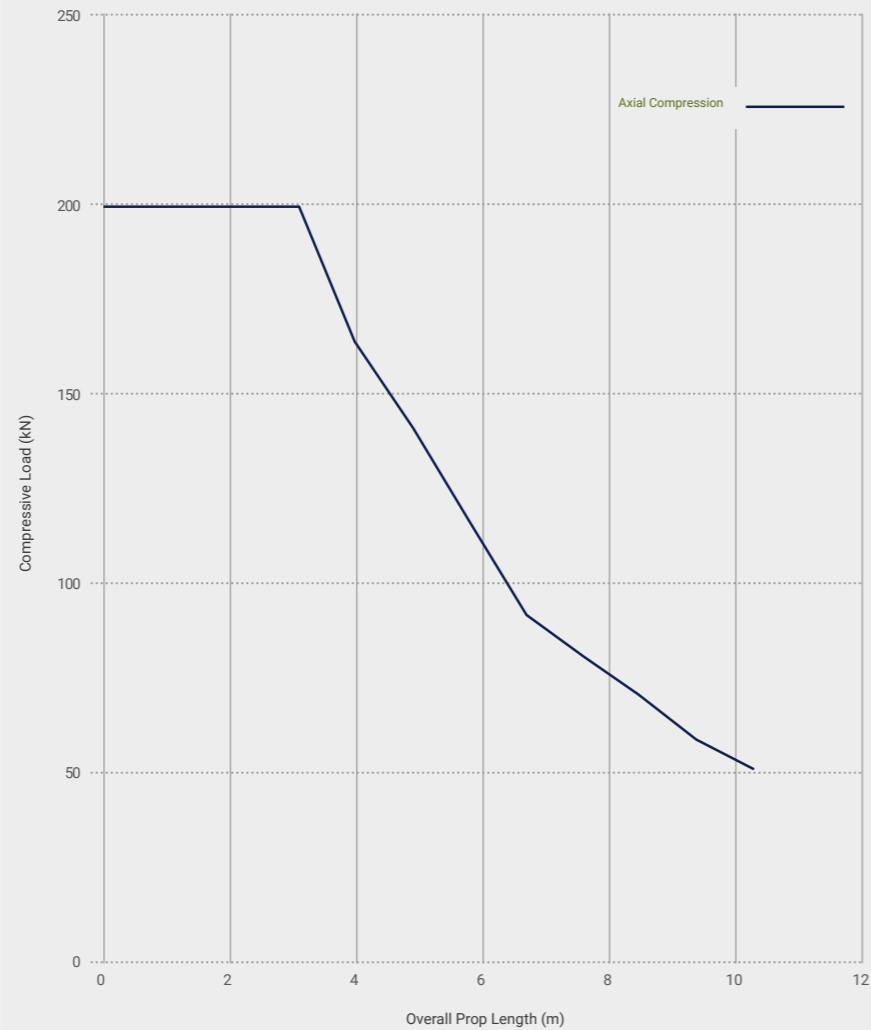

Safe Working Loads

The safe working loads for members and joints given here are generally based on theoretical values calculated in accordance with BS 449. In all cases a minimum factor of safety of 1.7 against the onset of permanent deformation has been established.

2. Needle Beams

System 160 Needle Beams allow loads to be shared between props. They are available in a number of UC sections, each allowing an increased bending moment up to a maximum of 376kNm.



Needle Beam

U.C. Section (kg/m)	Length (mm)	Material Grade	Maximum Bending Moment (kNm)	Weight (kg)
152 x 152 x 37	2000	S275	48	84
152 x 152 x 37	2500	S275	48	105
203 x 203 x 60	3000	S275	103	200
203 x 203 x 71	3000	S275	128	225
254 x 254 x 107	2000	S355	309	241
254 x 254 x 107	2500	S460	376	275
254 x 254 x 107	3030	S275	236	365

Ancillary Items

Pivot blocks, connectors and various plates are available as standard items from stock, further enhancing the flexibility of the System 160 range.



Fixed Head Unit



Gravlock Connector



Web Connector



Pivot Block



Swivel Connector



Push Pull Adjustable Base



90° Prop Unit Connector



Six Way Connector



Header Connector

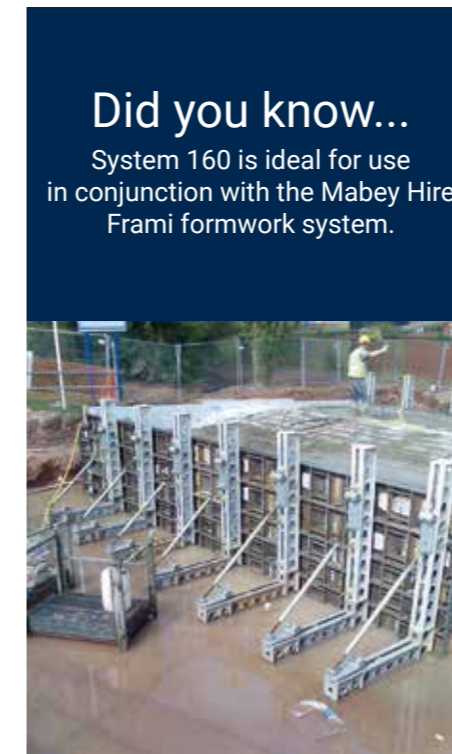

Did you know...

System 160 is ideal for use in conjunction with the Mabey Hire Frami formwork system.

For further information on any of propping and jacking systems please refer to our website at mabeyhire.co.uk

call us on 0330 191 3562 or email action@mabeyhire.co.uk



Mass 10

Our Mass range is one of the most versatile modular shoring and propping systems available on the UK market. Using a large range of off-the-shelf components with holes in both the flanges and the webs, allows the systems to be built up into a number of different configurations from individual shoring to stiff, efficient towers & trusses, and façade retention structures.

Putting the customer at the heart of our engineering, means the systems have been designed with maximum flexibility in mind. The Mass 10 components are compact and lightweight, with each of the soldiers weighing just 16kg/m, resulting in a propping solution for those areas where access is restricted. The Mass 10 system can be quickly and easily built up into a number of different configurations including stand alone propping and modular brace towers and can support loads of up to 200kN.

Configurations:

- Standalone Propping
- Modular Brace Towers
- Primary Beams
- Needlebeams

Applications:

- Demolition
- Formwork
- Parapet Replacement
- Ideal for applications where access is restricted



Mass 10

Components.

1. Props

The Prop unit forms the basis of the Mass 10 system. Fabricated from twin 3mm thick cold-formed channel sections with 14mm diameter holes in flanges and end plates allows the connection of Mass 10 auxiliary components. The Mass 10 prop units are available in 7 lengths allowing for many configurations.

Length (mm)	Weight (kg)
150	4.5
300	6.6
600	10.6
900	15.5
1200	19.7
1800	28.4
2700	41.8

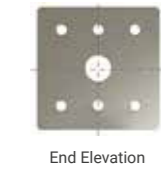

End Elevation

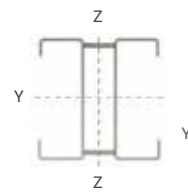

Mid Section

Section Properties

	Area (cm ²)	Moment of Inertia (cm ⁴)		Section Modulus (cm ³)		Radius of Gyration (cm)	
	A	I _{xx}	I _{yy}	W _{el,y}	W _{el,z}	i _y	i _z
Nett	15	450	306	60	41	5.4	4.5
Gross	16.7	541	348	72	46	5.6	4.5

Prop Loading Capacity

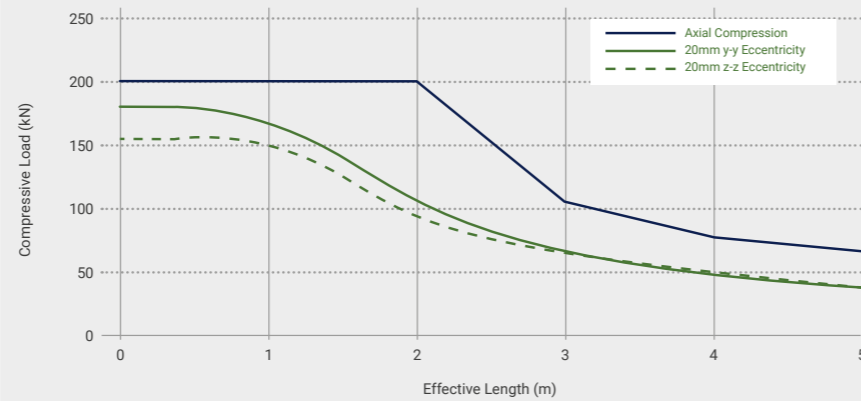

Bending Capacity

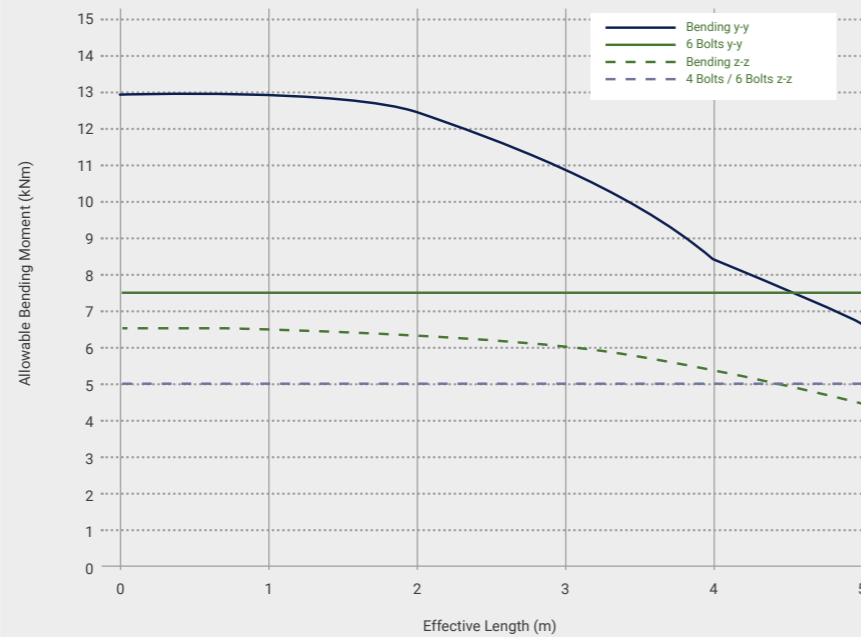

2. Needle Beams

Mass 10 Needle Beams allow loads to be shared between props, this enables trestles to be built using braces and vertical props.

The Mass 10 Needle Beams are available in a number of UC sections, each allowing an increased maximum bending moment up to a max of 376kNm.



Needle Beam

U.C. Section (kg/m)	Length (mm)	Material Grade	Maximum Bending Moment (kNm)	Weight (kg)
152 x 152 x 37	2000	S275	48	84
152 x 152 x 37	2500	S275	48	105
203 x 203 x 60	3000	S275	103	200
203 x 203 x 71	3000	S275	128	225
254 x 254 x 107	2000	S460	376	241
254 x 254 x 107	2500	S460	376	275
254 x 254 x 107	3030	S275	236	365

Ancillary Items

Adjustable ends, header beam connectors and base plates are available as standard items from stock, further enhancing the flexibility of the Mass 10 range.



Adjustable Pivot End
Compression = 100kN
Tension = 65kN



Adjustable Spherical End
Compression = 120kN
Tension = 0kN



Fixed Pivot End
Compression = 100kN
Tension = 100kN

Did you know...
Our 1.2m Mass 10 prop weighs under 20kg, making this system perfect for those projects with restricted access.

Eurocodes

The equipment has been assessed and is fully compliant to Eurocodes. Strengths relating to these codes are published in the technical data sheet for Mass 10.

For further information on any of propping and jacking systems please refer to our website at mabeyhire.co.uk

call us on 0330 191 3562 or email action@mabeyhire.co.uk



Mass 25

Ideal for the Building and Refurbishment market, our Mass range is one of the most versatile modular shoring and propping systems available in the UK market. Using a large range of off-the-shelf components with holes in both the flanges and the webs, allows the systems to be built up into a number of different configurations, from individual shoring to stiff, efficient towers and trusses and façade retention structures.

Putting the customer at the heart of our engineering means the systems have been designed with maximum flexibility in mind. The components are compact and lightweight, enabling manhandling if necessary, whilst the robust design of Mass 25, from galvanised cold formed steel allows it to support loads of up to 340kN on a single leg, meaning fewer components are needed and thus saving on assembly time. The system also has both mechanical and hydraulic capacity and can be supported with our real-time load monitoring system.

Configurations:

- Standalone Propping
- Modular Brace Towers
- Trusses
- Primary Beams
- Needle Beams

Applications:

- Vertical Propping
- Horizontal Shoring
- Formwork
- Needling
- Façade Retention
- Plan Bracing
- Parapet Replacement
- Travelling Gantries
- Hydraulic Propping



Mass 25

Components.

1. Props

The Prop unit forms the basis of the Mass 25 system. Fabricated from twin 4mm thick cold-formed channel sections (Material Grade: S420 MC), they are provided with 18mm diameter holes in flanges, webs and end plates to allow connection of Mass 25 grillage, bracing and auxiliary components. The Mass 25 prop units are available in seven lengths, allowing for many configurations.

Length (mm)	Weight (kg)
90	7.8
180	9.8
360	13.7
540	18.3
900	26.7
1800	47.6
2700	69.1



End Elevation

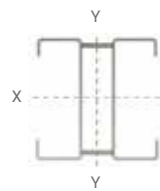

Mid Section

2. Bracing

Our bracing components allow Mass 25 props to be built into trusses and towers, adding even greater flexibility to the system.

Section	Width (m)	Height (m)
Truss	1.26 - 1.44	1.26 - 1.8
Frame	1.98	1.62
Angle	1.26 - 1.62	1.38 - 1.74

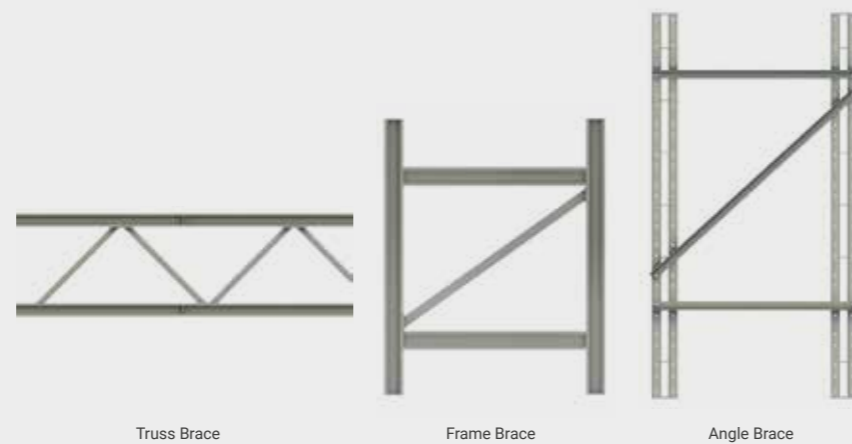

Truss Brace

Frame Brace

Angle Brace

Section Properties

	Area (cm ²)	Moment of Inertia (cm ⁴)		Section Modulus (cm ³)		Radius of Gyration (cm)	
	A	I _{xx}	I _{yy}	Z _{xx}	Z _{yy}	r _{xx}	r _{yy}
Nett	23.54	996	684	110	76	6.5	5.4
Gross	26.42	1219	789	135	87	6.8	5.5

Prop Loading Capacity

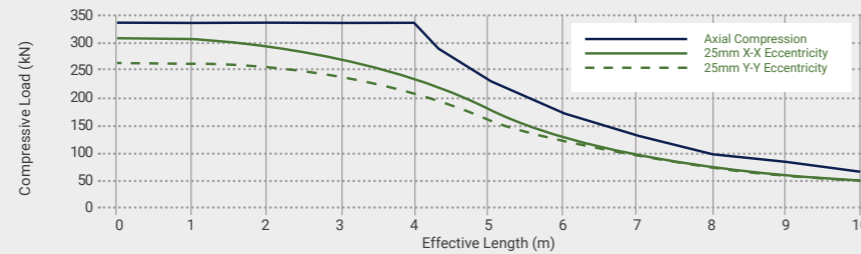

Bending Capacity

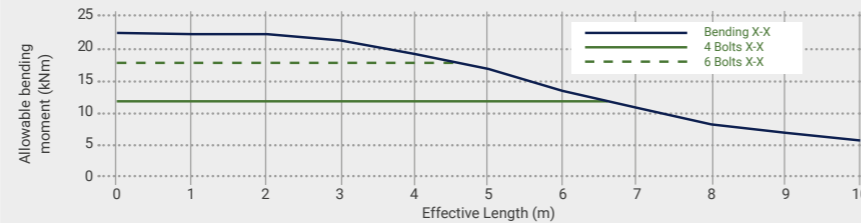

3. Grillage Beams

Mass 25 Grillage beams allow loads to be shared between props, allowing trestles to be built using braces and vertical props. The Mass 25 Grillage Beams are fabricated from 203x203x60kg/m UC sections (Material Grade S355 J2). Beams are provided with holes in flanges and end plates to accept Mass 25 props, bracing and auxiliary components.

Length (mm)	Weight (kg)
900	70.0
1800	132.1
2520	182.8
3240	233.5

Section Properties

	Area (cm ²)	Moment of Inertia (cm ⁴)		Section Modulus (cm ³)		Radius of Gyration (cm)	
	A	I _{xx}	I _{yy}	Z _{xx}	Z _{yy}	r _{xx}	r _{yy}
Nett	66.2	5147	1694	491	165	8.82	4.9
Gross	76.4	6125	2065	584	201	8.96	5.2

Load Capacity - Bending (for an effective length of 2m)

Bending Capacity (kNm)	Section x-x	Joint Capacity x-x
		95

Ancillary Items

Adjustable ends, pivot ends and base plates are available as standard items from stock, further enhancing the flexibility of the Mass 25 range.

Did you know...

Ideal for use where space is limited, our Flat Jacks are the perfect complement to the Mass 25 system.

For more information, see page 47.



Adjustable Pivot End
Compression = 210kN*
Tension = 85kN
*prop length at 3m



Adjustable Spherical End
Compression = 220kN
Tension = 0kN



80° Pivot End
Compression = 250kN
Tension = 120kN



Wall Plate



Single Base Plate

Safe Working Loads

The safe working loads for members and joints given here are generally based on theoretical values calculated in accordance with BS 449 and BS 5975 but with additional safety factors applied to ensure a minimum factor of safety of 2.0.

For further information on any of propping and jacking systems please refer to our website at mabeyhire.co.uk

call us on 0330 191 3562 or email action@mabeyhire.co.uk

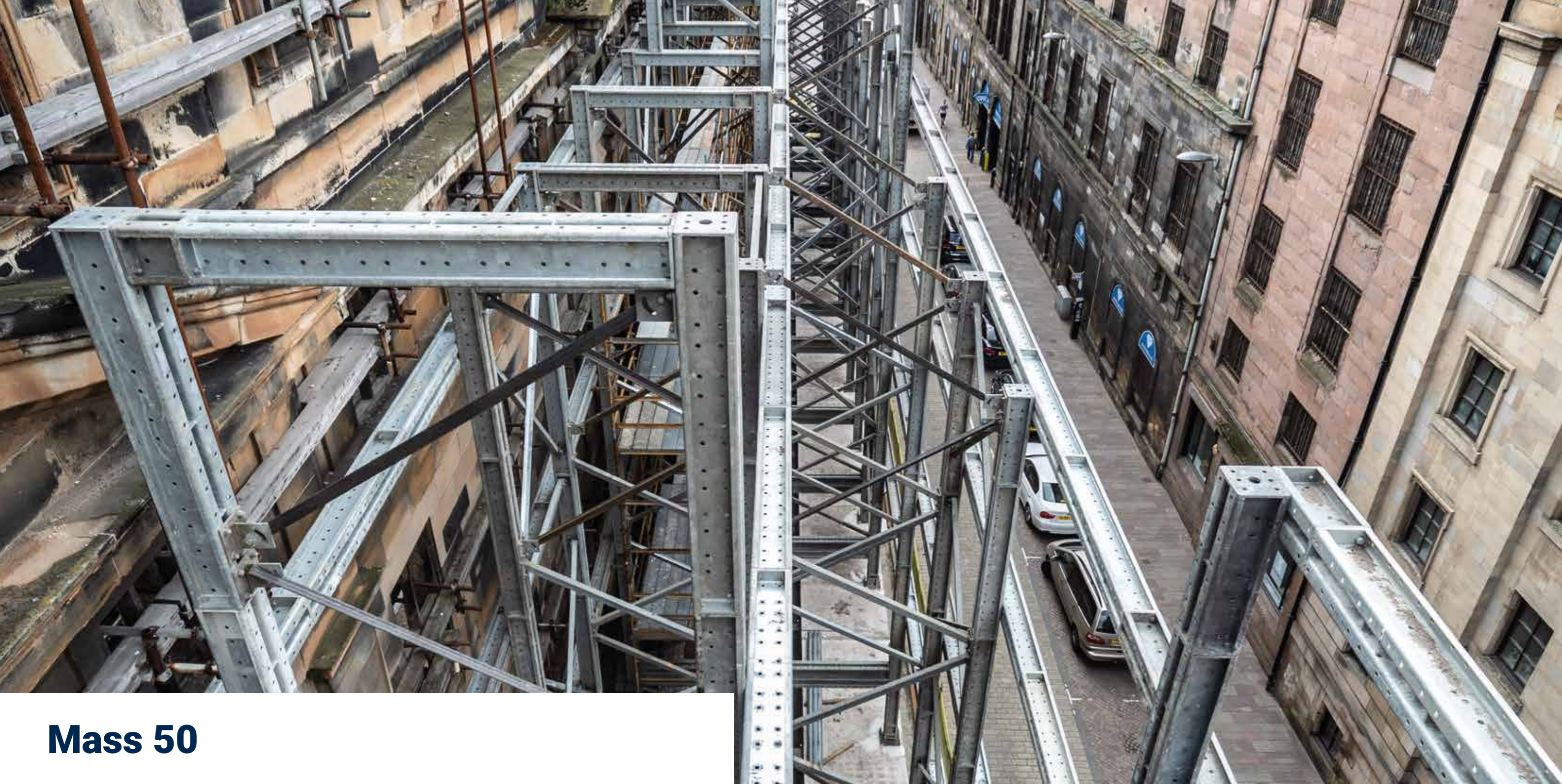

Mass 50

Ideal for the Building and Refurbishment market, our Mass range is one of the most versatile modular shoring and propping systems available on the UK market. Using a large range of off-the-shelf components with holes in both the flanges and the webs, allows the systems to be built up into a number of different configurations, from individual shoring to stiff, efficient towers and trusses or to form large, complex façade retention structures.

Putting the customer at the heart of our engineering means the systems have been designed with maximum flexibility in mind. The components are compact, enabling manhandling if necessary, whilst the robust design of Mass 50, from galvanised cold formed steel allows it to support loads of up to 600kN on a single leg, meaning fewer components are needed and thus saving on assembly time. The system also has both mechanical and hydraulic capacity and can be supported with our real-time load monitoring system.

Configurations:

- Standalone Propping
- Modular Brace Towers
- Trusses
- Grillages

Applications:

- Vertical Propping
- Horizontal Shoring
- Raking Propping
- Formwork
- Needling
- Facade Retention
- Plan Bracing
- Parapet Replacement
- Travelling Gantries
- Hydraulic Propping



Mass 50

Components.

1. Props

The Prop unit forms the basis of the Mass 50 system. They are fabricated from twin 5mm thick cold-formed channel sections (Material Grade: S355 J0). The 22mm diameter holes in flanges, webs and end plates allows the connection of Mass 50 grillage, bracing and auxillary components. The Mass 50 prop units are available in 8 lengths allowing for many configurations.

Length (mm)	Weight (kg)
100	17
250	22.5
500	32.1
1000	52.2
1500	70.6
2000	90.9
2500	110.5
3000	130.3



End Elevation

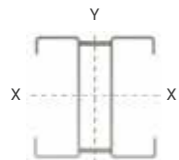

Mid Section

Section Properties

	Area (cm ²)	Moment of Inertia (cm ⁴)		Section Modulus (cm ³)		Radius of Gyration (cm)	
	A	I _{xx}	I _{yy}	Z _{xx}	Z _{yy}	r _{xx}	r _{yy}
Nett	38.2	3501	2027	280	162	9.6	7.3
Gross	47.0	4273	2340	342	187	9.5	7.1

Prop Loading Capacity

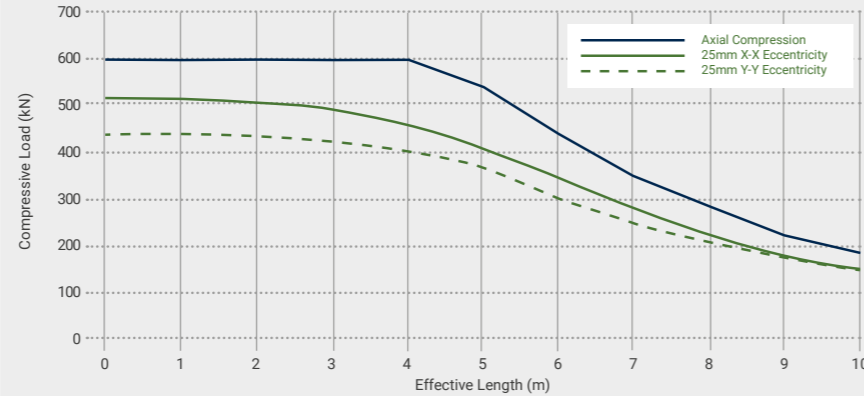

Bending Capacity

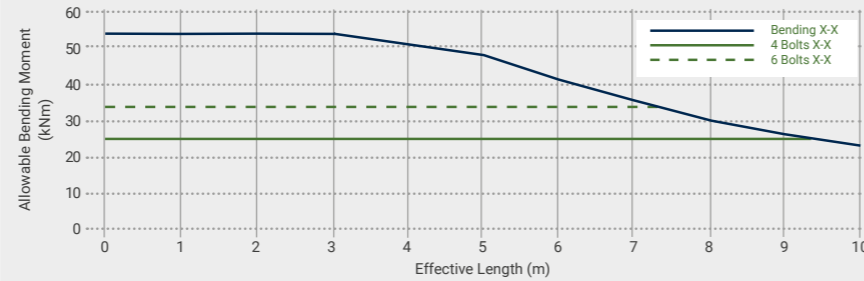

2. Bracing

Our bracing components allow Mass 50 props to be built into trusses and towers, adding even greater flexibility to the system.

Section	Width (m)	Height (m)
Angle	1.5 – 3.5	1.5 – 3.5
Truss	1.25 – 1.5	1.25 – 2.5
Frame	2.5 – 3.25	2.5 – 3.5

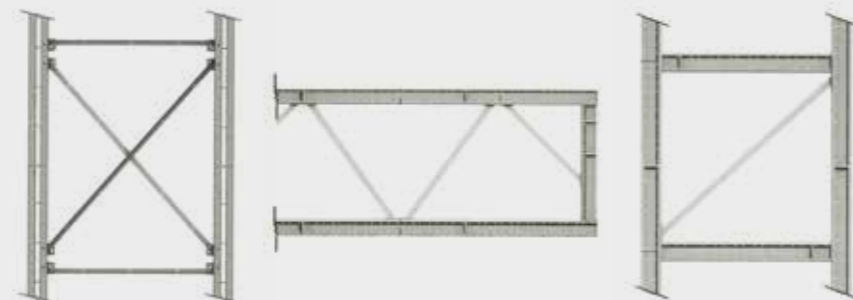

Angle Brace & Cleats

Truss Brace

Frame Brace

3. Grillage Beams

Mass 50 Grillage beams allow loads to be shared between props, allowing trestles to be built using braces and vertical props. The Mass 50 Grillage Beams are fabricated from 254x254x107kg/m UC sections (Material Grade: S275 J0). Beams are provided with 22mm diameter holes in flanges, webs and end plates to accept other Mass 50 components enabling a true modular system.

Length (mm)	Weight (kg)
1000	137.3
2000	259.3
3500	441.3
5000	631.8

Section Properties

	Area (cm ²)	Moment of Inertia (cm ⁴)		Section Modulus (cm ³)		Radius of Gyration (cm)	
	A	I _{xx}	I _{yy}	Z _{xx}	Z _{yy}	r _{xx}	r _{yy}
Nett	112.7	14627	4905	1097	379	11.4	6.6
Gross	136.4	17510	5928	1313	458	11.3	6.6

Load Capacity - Bending (for an effective length of 2m)

	Section x-x	Joint End Plate Capacity x-x	Joint with TF020 Cover Plate in Tension (6 Bolts Each Side)	Joint with TF028 Cover Plate in Tension (10 Bolts Each Side)
Bending Capacity (kNm)	170	25*	55*	90*

*limited by section properties



Ancillary Items

Adjustable ends, pivot ends and base plates are available as standard items from stock, further enhancing the flexibility of the Mass 50 range.

Did you know...
We also offer a comprehensive range of hydraulic jacking systems. Find out more about our hydraulic jacking offering on page 44.

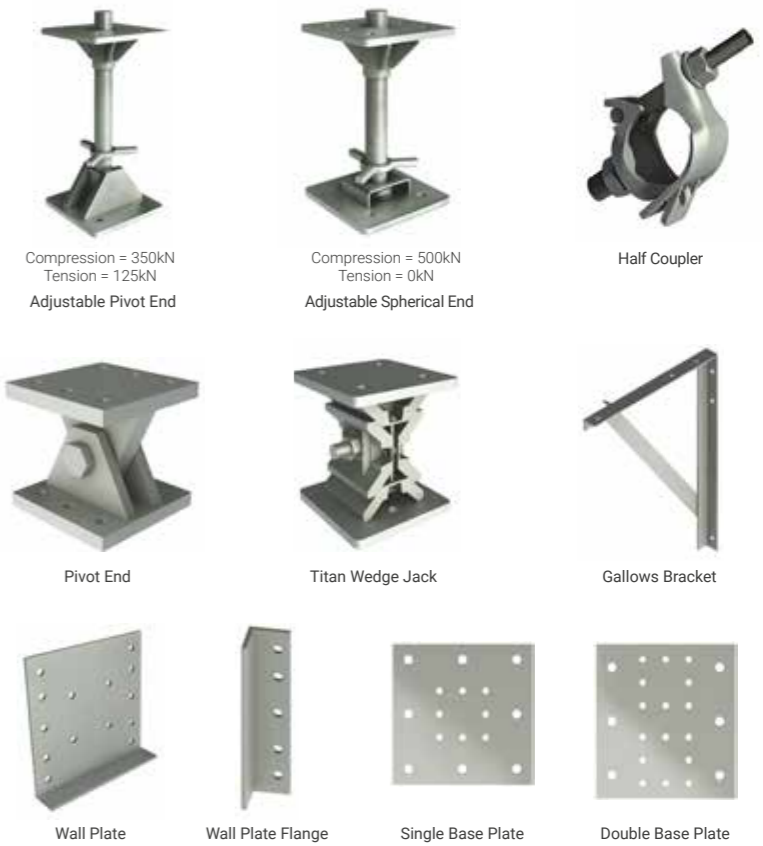

Safe Working Loads

The safe working loads for members and joints given here are generally based on theoretical values calculated in accordance with BS 449 and BS 5975 but with additional safety factors applied to ensure a minimum factor of safety of 2.0.

Eurocodes

The equipment has been assessed and is fully compliant to Eurocodes. Strengths relating to these codes are published in the Eurocode version of the technical data sheet for Mass 50.

For further information on any of propping and jacking systems please refer to our website at mabeyhire.co.uk

call us on 0330 191 3562 or email action@mabeyhire.co.uk



Mat 125

Our Mat 125 system is a high strength, robust and versatile propping system offering a capacity of up to 1550kN per column, which can be used as individual propping or built into high strength towers and trusses. Full compatibility with the Mabey Hire Mass range and with our range of Hymat hydraulic jacks, further increases the versatility of this system.

Configurations:

- Stand-alone Propping
- Modular Brace Towers
- Trusses

Applications:

- Bridge Support
- Façade Retention
- Heavy Duty Falsework
- Hydraulic Propping
- Bearing Replacement



Mat 125

Components.

1. Props

The Prop Unit forms the basis of the Mat 125 system, has a working load of 1550kN per prop, and is regularly used in conjunction with our Hymat Jack System to pre load, strike or lift from the top of the props. Available in heights from 0.6m to 3.6m and with 22mm diameter holes in the webs and the batten and end plates, allows the connection of the Grillage and bracing components.

Length (mm)	Weight (kg)
610	110.5
914	133.9
1219	158.1
1829	222.0
2438	270.5
3658	383.0



End Elevation

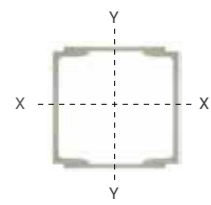

Cross Section

Section Properties

	Area (cm ²) A	Moment of Inertia (cm ⁴)		Section Modulus (cm ³)		Radius of Gyration (cm)	
		I _{xx}	I _{yy}	Z _{xx}	Z _{yy}	r _{xx}	r _{yy}
Nett	74.9	5565	11568	438.2	847.4	8.6	12.4
Gross	94.8	7597	14122	598.2	1034.6	8.9	12.2

Prop Loading Capacity

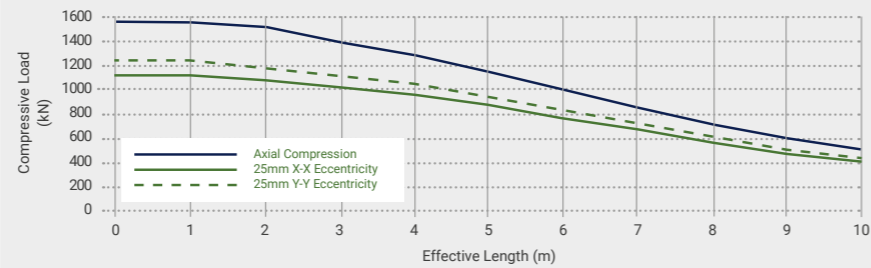

Bending Capacity

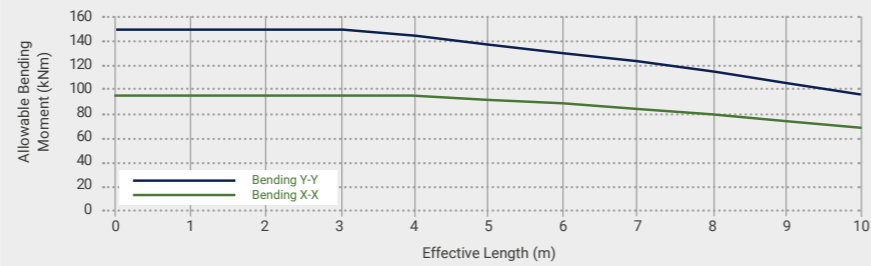

2. Bracing

Mat 125 includes a range of angle bracing that bolts directly to the prop units via bracing cleats. These enable users to create simple stable towers and prop lines.



Tower Elevation Assembly



Plan Bracing Assembly in Plan View

A range of angle braces are available to brace the MAT 125 columns at 1500mm or 3000mm centres to form high load towers or braced column rows.

Plan braces and brackets are available to brace tower structures.

3. Grillage Beams

The Mat 125 Grillage Beams are available in standard and heavy RSJ sections. Available single or in joist pairs, all grillage beams are provided with 22mm diameter holes in the flanges and webs to accept Mat 125 Props and other components enabling a true modular system.

Length (mm)	Standard Weight (kg)	Heavy Weight (kg)
1524	220.9	266.0
2083	295.6	357.7
2564	358.2	434.5
3046	419.7	509.9
3607	507.9	615.7
4570	631.3	766.3
6094	843.0	1024.4
7618	1054.8	1279.5
9142	1266.4	1538.6

Section Properties

	Area (cm ²) A	Moment of Inertia (cm ⁴)		Section Modulus (cm ³)		Radius of Gyration (cm)	
		I _{xx}	I _{yy}	Z _{xx}	Z _{yy}	r _{xx}	r _{yy}
Standard	Single Joist Nett	71.6	11203	774	666	102	12.3
	Single Joist Gross	83.9	13185	921	865	121	12.5
	Paired Joist Nett	143.1	22407	*	1332	*	12.5
	Paired Joist Gross	167.8	26370	*	1730	*	12.5
Heavy	Single Joist Nett	87.1	13242	994	787	130	12.3
	Single Joist Gross	102.5	15640	1177	1026	154	12.4
	Paired Joist Nett	174.2	26484	*	1574	*	12.3
	Paired Joist Gross	205.0	31280	*	2052	*	12.4

*Y-Y values for paired joists omitted as joists are not fully structurally connected eg with batten plates

Load Capacity - Bending (for an effective length of 3m)

	Section x-x		Section x-x	
	Standard	Heavy	Standard	Heavy
Bending Capacity Single (kNm)	80	100	80	100
Bending Capacity Pair (kNm)	160	200	160	200

*Bending capacity may be reduced if co-existent shear

Ancillary Items

Adjustable ends, connectors and connector plates are available as standard items from stock, further enhancing the flexibility of the Mat 125 range.



Adjustable Screw End



Push Pull Swivel Connector



Prop Hinge Unit



Access Bearer

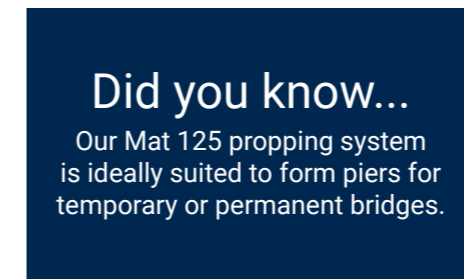

Safe Working Loads

The safe working loads for members and joints given here are generally based on theoretical values calculated in accordance with BS 449 and BS 5975 but with additional safety factors applied to ensure a minimum factor of safety of 2.0.

For further information on any of propping and jacking systems please refer to our website at mabeyhire.co.uk

call us on 0330 191 3562 or email action@mabeyhire.co.uk



Superprop

Our Superprop system is a high load propping system with integrated adjustment and hydraulic pre load/lifting facility. With its unique pinned joints, the system is quick to assemble and provides a load capacity of up to 1950kN. Superprop combines the flexibility of an off-the-shelf solution with high load capacities and is widely used for the support and lifting of bridge decks and heavy loads.

Configurations:

- Standalone Propping
- Modular Brace Towers
- Raking Props

Applications:

- Heavy Duty Vertical Propping
- Heavy Duty Horizontal Shoring
- Bearing Replacement
- Hydraulic Propping



Superprop

Components.

1. Props

Each prop has a maximum working load of 1950kN and features adjustable heads and bases with the facility to add hydraulic jacks for pre-loading or lifting operations.

Height (mm)	Component	Weight (kg)
50	Plate	76
385	Extension	197
762	Prop	187
1000	Extension	260
1524	Prop	277
3048	Prop	462

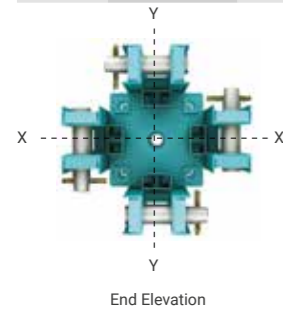

Section Properties

	Area (cm ²) A	Moment of Inertia (cm ⁴)		Section Modulus (cm ³)		Radius of Gyration (cm)	
		I _{xx}	I _{yy}	Z _{xx}	Z _{yy}	r _{xx}	r _{yy}
Nett	106.2	23690	23690	940	940	14.9	14.9
Gross	135.0	19850	19850	1117	1117	12.1	12.1

Prop Loading (eccentricity = 10mm)

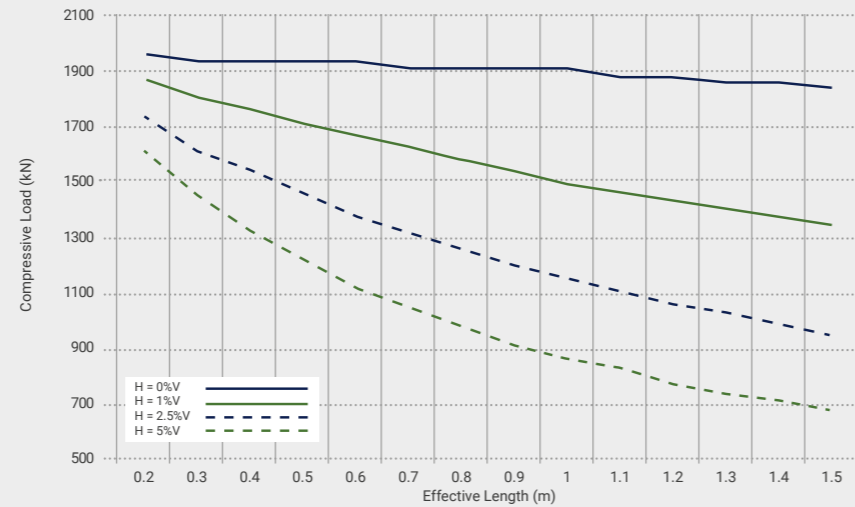

2. Grillage / Header Beams

The Superprop grillage beams feature a unique full strength pinned splice arrangement. These connect to the heads and bases of the props to provide load transfer or spreading arrangements.

Pin to Pin (mm)	Weight (kg)
2000	517.8
4000	800
6000	1163.6



Header Beam End Elevation

Section Properties

	Area (cm ²) A	Moment of Inertia (cm ⁴)		Section Modulus (cm ³)		Radius of Gyration (cm)	
		I _{xx}	I _{yy}	Z _{xx}	Z _{yy}	r _{xx}	r _{yy}
Single Beam	85.5	24329	1365	1188	153	16.9	4.0
Twin Beam	171.0	48660	29448	2376	1373	16.9	13.1

Grillage Beam Pin Hole Centres

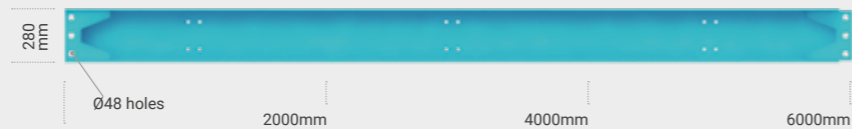

3. Bracing

Superprop is braced using a special bracing panel that bolts into the chord blocks using chord bolts. The panels are a standard 1549mm wide (prop centres 2050mm) and are available in heights of 1524mm and 3048mm.

Height (mm)	Width (mm)	Weight (kg)
1524	1549	160
3048	1549	267

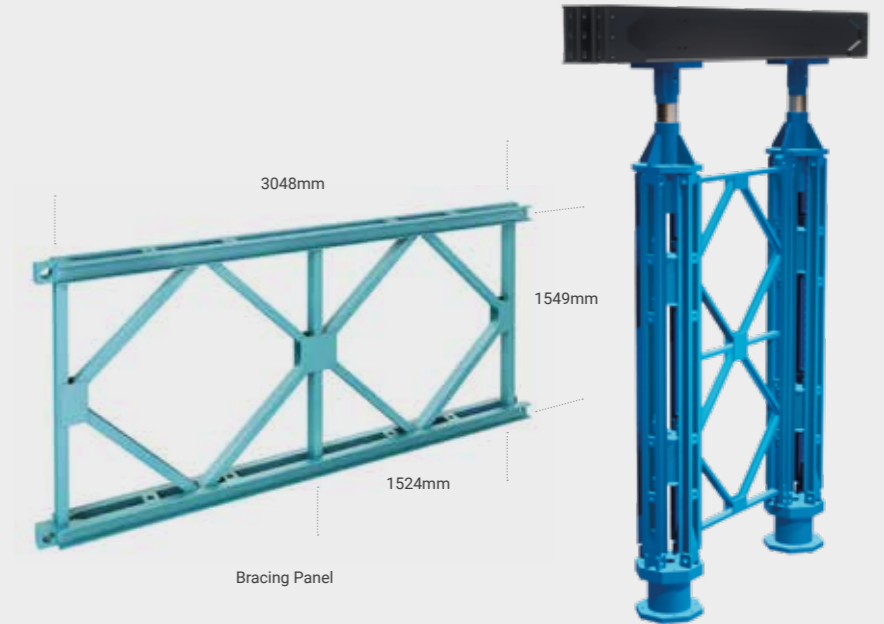

Ancillary Items

Adjustable heads, base units and extensions are available as standard items from stock, further enhancing the flexibility of the Superprop range.



Adjustable Base Unit



Adjustable Head Unit



Base Unit



385mm Extension

Did you know...

Superprop grillage beams are often used to provide cable or service support during bridge replacement operations.



Safe Working Loads

The safe working loads for members and joints given here are generally based on theoretical values calculated in accordance with BS5975 and BS449 as well as the component capacities that have been derived from full scale tests. Where full scale tests have been carried out a minimum factor of safety of 1.7 against the onset of permanent deformation has been established.

Eurocodes

The equipment has been assessed and is fully compliant to Eurocodes. Strengths relating to these codes are published in the technical data sheet for Superprop.

For further information on any of propping and jacking systems please refer to our website at mabeyhire.co.uk

call us on 0330 191 3562 or email action@mabeyhire.co.uk



MU Towers

Our Mabe Universal Towers were designed in-house by our highly experienced engineers and have been used on some of the biggest propping projects in the UK for example the construction of the Mersey Gateway.

Extremely heavy duty, this system is unique to the UK market in its ability to support loads of up to 8000kN (approx. 800 tonnes) and can be used as a free standing tower.

Our MU tower system is made up of a small number of components allowing a large section of the tower to be built very quickly. The tower can be erected in situ or as separate sections on the ground and lifted in by crane.

As every situation requiring this solution is so unique, please contact our team to discuss this system in more detail, at action@mabeyhire.co.uk or 0330 191 3562.





Jacking

Our extensive range of hydraulic jacks, flat jacks, ancillaries and control equipment has been developed to provide the construction and allied industries with an unrivalled service for the controlled application of high load hydraulic systems. For each individual project with a hydraulic element our Project Engineers and Hydraulic Technicians will design and detail the jack layout, hydraulic pressurising and control system best suited to our clients' specific application.

Applications:

- Major Lifting
- Monitoring & Control
- Weighing
- Pre-Loading
- Hydraulic Sliding
- Stressing & Testing

Design Codes

All of our hydraulic cylinders comply with the accepted industry standards BS EN 1494:2001 and ASME B30.1, a code recognised and accepted by Highways England.

Testing

All our hydraulic equipment is subject to a rigorous in house inspection and testing regime, developed in line with ISO 9001:2000 and LOLER.

Jacking Capabilities

Offering one of the largest fleets of hydraulic jacks and ancillaries in the UK, our extensive range is available as part of a design or straight hire. Our team of hydraulic experts ensure that every jack is fully tested and issued with a calibration certificate prior to every hire.

Site Services

Our Jacks can be used for a wide range of hydraulic site services from stressing and tensioning to onsite load testing



Major Lifting

Our wide range of hydraulic jacking systems can be used with or without our propping systems for precise controlled hydraulic movement. Ideal for major lifting projects such as bridge jacking and the lifting & lowering of other large, heavy structures eg containers, machinery etc.



Monitoring & Control

Our bespoke solutions and unrivalled experience in the movement of structures using controlled hydraulic jacking systems, have enabled us to develop and design synchronised pumps and computer controlled jacking techniques. All supported by our live data monitoring which ensures mitigation management by minimising risks and potential failure.



Weighing

Integrated hydraulic jacks with load monitoring capabilities allows us to accurately weigh large, heavy structures or industrial containers, silos and tankers etc.



Pre-Loading

Hydraulic jacks can be used in pre-loading applications from structural steel to pre-load structural shoring. Flat jacks can be used in temporary pre-load applications but can also be used to form a permanent part of a structure when they are filled with resin.



Hydraulic Sliding

Hydraulically moving a heavy structure horizontally, from one position to another eg, machinery, containers. This can be achieved by using hydraulic push/pull jacks and PTFE slide bearings.



Stressing & Testing

The stressing technique uses hydraulic jacks to apply force to bolts or cables to strengthen for pre-loading. Hydraulic jacks can also be used for testing to ensure the structure/component has been installed correctly and can safely withstand the load imposed on them.

For further information on any of propping and jacking systems please refer to our website at mabeyhire.co.uk

call us on 0330 191 3562 or email action@mabeyhire.co.uk

Jacks



Plain Ram Jacks

All Jacks in this range are single acting, incorporating a 5° spherical head. This jack series is lightweight and versatile, intended for general use or in conjunction with the full range of our propping systems.

Hymat Jacks

Unique to Mabey Hire, the Hymat Jack is a lightweight alloy cylinder designed by our engineers for general use or in conjunction with the full range of our propping systems. The Hymat has an external locking collar providing greater stability. The versatile cylinder can be used with a variety of head and base plates, including a spherical head which allows a 5° rotation.



Screwed Ram Jacks

We offer a range of Screwed Ram Jacks for general use. All jacks in this range are single acting, and incorporate a 5° spherical head. The Screwed Ram Jacks include a threaded locking collar to allow load transfer from the hydraulic ram, providing a mechanical load path.



Low Height Jacks

Our Low Height Jacks have a screw ram and locking collar and are designed for use in areas where headroom is limited. Their low profile means they are ideal for use on bridge bearing replacements.



Hollow Ram Jacks

Available in single or double acting, this range is intended for use with a threaded bar system such as Dywidag. Jacks can be used in conjunction with our Mass 50 system (see p26), adopting specially fabricated base plates to ensure concentric connection. The hollow plunger allows both pull & push forces and enables fast ram retraction.



Climbing Jacks

The Climbing Jack system is designed to raise or lower heavy loads through greater distances than conventional jacks. The system "climbs" using double acting hydraulic jacks on stacks of Ekki timber located within a guide frame.

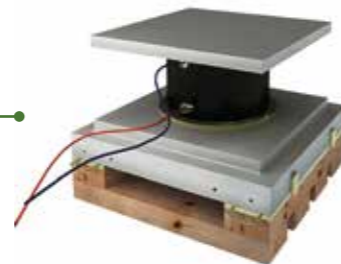

Jack Capabilities

	Capacity (kN)	Stroke (mm)	Closed Height (mm)	Diameter (mm)
1 Plain Ram Jacks	101-500	100-400	175-540	57-170
2 Hymat Jacks	736	50-300	215-505	254
3 Screwed Ram Jacks	245-5110	30-200	135-516	95-400
4 Low Height Jacks	490-5101	Dec-45	60-192	175-400
5 Hollow Ram Jacks	265-576	155-330	323-521	114-159
6 Climbing Jacks	1470-4415	150	460-510	250-470

Did you know...

All our Hydraulic Jacks can be Computer Controlled

Allowing you to remotely control the movement of the structure. This can be linked to our advanced monitoring solutions, giving us the ability to carefully monitor your structure, and provide you with real-time data and built-in warnings and stop alarms on our LIVESite platform.



Flat Jacks*

Due to the low profile of our flat jacks they can be used in the tightest of spaces, used in lifting, lowering, pre-tensioning and stressing. They can be both a temporary solution or part of a permanent design.

*Do not have hydraulic or computer controlled capabilities.



Jack Capabilities

	Capacity (kN)	Stroke (mm)	Closed Height (mm)	Diameter (mm)
Flat Jacks	79-3393	25	32	120-600

For further information on any of propping and jacking systems please refer to our website at mabeyhire.co.uk

call us on 0330 191 3562 or email action@mabeyhire.co.uk

Monitoring

We also offer an industry-leading range of monitoring solutions designed to provide you with vital, real-time information about structural movement and environmental impact.

Our expert team brings together a wealth of engineering experience with cutting edge technology to give you highly accurate measurement and real-time information about stress, load, noise and more. All of your data is instantly visible through our unique control of your site's safety, delivering both assurance and compliance.

Applying structural monitoring solutions to your project is an ideal way to monitor the behaviour of your temporary structure. It will provide you with added assurance and confidence in the scheme, especially given that loading levels can change from day-to-day, depending on the amount and type of traffic using the bridge.

With structural monitoring, project teams can gain valuable insight and view live load data, as well as set up alert systems should the loading exceed a pre-determined level.

There are also numerous environmental factors that can impact the conditions on site or surrounding area, e.g. noise, dust, vibration, rainfall etc. Enviroguard continuously measures all of these factors plus more, analysing the site conditions to ensure compliance to Section 61 of the Control of Pollution Act 1974.

To talk to us about a monitoring solution for your project, call 0330 191 5594 or email us at action@mabeyhire.co.uk.



Our project management approach ensures you get the full monitoring solution, from start to finish.

Step 1 System planning & design

Early engagement with our clients ensures that our expert engineers design a tailored monitoring solution to all projects.

Step 3 Data configuration

Our unique web based reporting software, Mabey LIVEsite is pre-configured for each project based on a clear understanding of client needs with built in trigger levels to alert users to any breaches.

Step 5 Reporting

Templates are set up within the LIVEsite system to enable quick and easy reporting.



Step 2 Installation & configuration

Our team will install and ensure accurate configuration of all monitoring equipment on site.

Step 4 Data visualisation

Clients are able to view accurate, real-time data that is easy to interpret through the use of graphs, schematics and 3D modelling.

L_{Aeq} (1 Hr) [dB]
65.80 dB

10/11/2018
17:10:41



Engineering the future

Here at Mabey Hire, we are committed to driving our industry forward. Whether through using the latest technologies or through learning and development, we are constantly looking for ways to improve safety and efficiency for our customers.

With a dedicated digital engineering team embedded in our business, we use the latest technology to help our customers design winning bids, reduce the costs of construction, speed up delivery, improve safety and reduce the full-life cost of infrastructure.

We are extremely passionate about raising standards in the temporary works industry, that's why we have invested in our ICE accredited training programme and developed our STEM Education Programme.

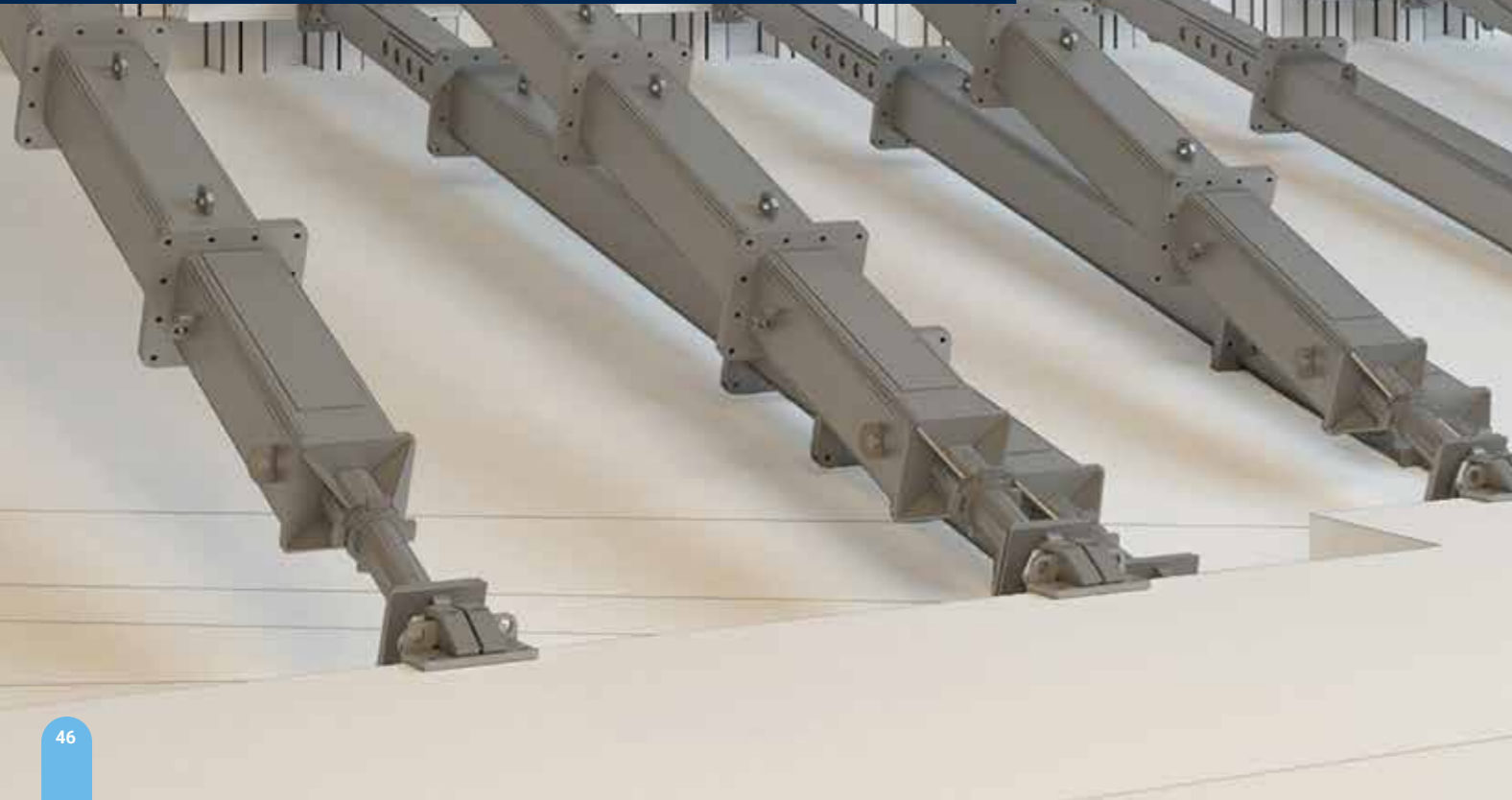

Immersive Technology

Developed by our in-house engineers, EVE uses immersive technology to create an intuitive 3D design for your construction project, incorporating all aspects of temporary works.

Rendering a fully explorable visualisation of your project, EVE allows users to see the full project before construction work begins.

BIM (Building Information Modelling)

Our early adoption of Revit 3D software in our scheme designs, enabled us to further help our clients to win and deliver projects. We have the capability/processes to work to BIM level 2 standards.

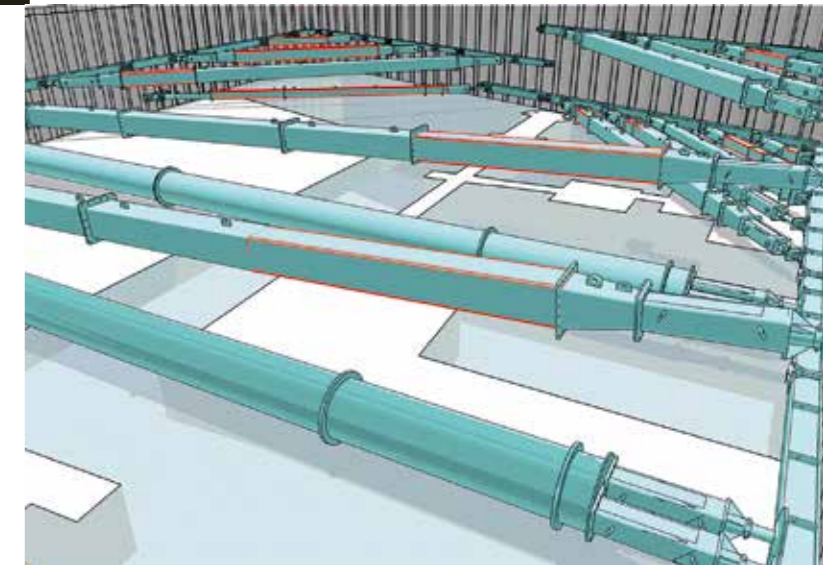

STEM (Science, Technology, Engineering & Mathematics)

We take our responsibility for encouraging the next generation of engineers seriously. That's why we have built the STEM Education programme, using LEGO® to inspire children to consider a career in engineering, delivered by our own STEM Ambassadors, enabling a new generation of engineers to take our industry forward.



Learning & Development

With our in-house ICE accredited training programme we are committed to supporting the development of our engineers to raise standards within the temporary works industry.

The ICE has approved our structured training agreement and many of our engineering team are either Fellows of the ICE, Chartered Engineers or are working towards professional qualifications.

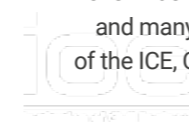







Working with Mabe Hire

Any delay impacts a construction project significantly, so our customers demand a right first time service. We have built our business to ensure we meet that need.

As an award-winning temporary works specialist - we have the knowledge, experience and the support network to ensure we deliver an unrivalled service. This ensures we can deliver a quick and efficient solution, from design through to delivery and installation, throughout the UK.

This service is backed by our commitment to quality, safety and the environment.

<p>4.8/5</p>  <p>CUSTOMER SATISFACTION RATING</p>	<p>£2M</p>  <p>ANNUAL INVESTMENT IN EQUIPMENT</p>	<p>98.75%</p>  <p>ON TIME IN FULL INVOICE CORRECT</p>	<p>£1M</p>  <p>ANNUAL INVESTMENT IN VEHICLES</p>	<p>GET IT RIGHT INITIATIVE</p> <p>We're committed to eliminating error within the construction industry. With our membership to GIRI (Get It Right Initiative), we're working directly with them and other members to improve productivity, quality, sustainability and safety through the drive of innovation and sharing of best practice.</p>
----------------------------------------------------------------------------------------------------------------------------------------------------	----------------------------------------------------------------------------------------------------------------------------------------------------	--------------------------------------------------------------------------------------------------------------------------------------------------------	---------------------------------------------------------------------------------------------------------------------------------------------------	---------------------------------------------------------------------------------------------------------------------------------------------------------------------------------------------------------------------------------------------------------------------------------------------------------------------------------------------------------

Site services

Successful completion of any contract requires co-operation and a desire to succeed from all parties. Our mission is to bring the benefit of our market-leading products together with our experienced engineers and our installation capability to offer safe, economic and least intrusive temporary works solutions, delivered on time and on budget. Our site management and installation teams work closely with the engineers and our clients to advise, plan and execute works on site in a safe, timely manner with due regard to the needs of others working around us.

Customer service excellence

We pride ourselves on our commitment to customer service excellence and regularly conduct external research to refine and improve our service offering, striving for complete customer satisfaction.

Commitment to quality, safety and the environment

Our health and safety programme has been recognised by numerous professional bodies across the construction and manufacturing industry.

TAKING RE:SPONSIBLE ACTION



ESG

Our activities help shape the world we live in and leave a lasting impact. That's why we're committed to protecting the planet, caring for our people and communities, and being a responsible business.

ESG stands for Environmental, Social and Governance and our strategy sets out how we're taking responsibility for protecting the planet, people and communities to achieve a sustainable future, from the way we behave and operate as a business, to the actions we all take every day.

Discover our full ESG strategy at: mabeyhire.co.uk/esg

RE:AFFIRMING OUR COMMITMENTS



PROTECTING THE PLANET

Taking action today to protect our planet's future

- Net Zero by 2035
- Enhancing biodiversity
- Reducing waste to landfill
- Paper-lite business



CARING FOR PEOPLE & COMMUNITY

Supporting a fair and inclusive society

- Providing an inclusive workplace with equal opportunities
- Engaging with the communities we work in
- Early career engagement
- Supporting our people



BEING A RESPONSIBLE BUSINESS

Doing the right thing, always

- Fair and rewarding remuneration
- A compliant and responsible business
- Responsible procurement and supply chain management
- Transparent reporting



Mabey Hire Near You

NORTH

GLASGOW

T: 01417 793535

Woodhead Rd, Muirhead, Chryston, Glasgow, G69 9JD

ABERDEEN

T: 01358 723650

Ellon Commercial Park, Balmacassie, Ellon, AB41 9RD

INVERNESS

T: 01463 239222

41 Lotland Street, Inverness, IV1 1ST

DURHAM

T: 01915 175600

Parkgate, Hetton Lyons Industrial Estate, Houghton-Le-Spring, DH5 0RH

GARSWOOD

T: 01942 725341

198 Gibbons Road, Garswood, Nr Wigan, Lancashire, WN4 0YA

DEWSBURY

T: 01924 464695

1-5 Railway Street, Scout Hill, Ravensthorpe, WF13 3EJ

NOTTINGHAM

T: 01159 301154

Oakwood Grange, Robinettes Lane Cossall, Nottinghamshire, NG16 2RX

BILSTON

T: 01902 404512

Stag Industrial Estate, Oxford Street, Bilston, West Midlands, WV14 7HZ

SOUTH

BURY ST EDMUNDS

T: 01284 767600

Mercers Road, Compiegne Way, Business and Industrial Park, Bury St. Edmunds, Suffolk, IP32 7HX

STROOD

T: 01634 722465

Commissioners Road, Strood, Rochester, Kent, ME2 4EQ

HATFIELD

T: 01707 267171

Dennis Works, Traveller's Lane, Welham Green, Hatfield, Herfordshire, AL9 7HN

NEWTON ABBOT

T: 01626 833391

Fairfax Road, Heathfield Industrial Estate, Newton Abbot, Devon, TQ12 6UD

ROMSEY

T: 01794 515666

Belbins Business Park, Cupernham Lane, Romsey, Hants, SO51 7JF

WELLINGBOROUGH

T: 01933 441155

15 Bradfield Close, Finedon Road Ind Est, Wellingborough, Northamptonshire, NN8 4RQ

CALNE

T: 01249 821193

Harris Road, Porte Marsh Industrial Estate, Calne, Wiltshire, SN11 9PT

CARDIFF

T: 02920 396621

Gulf Works Industrial Estate, Penarth Road, Cardiff, CF11 8TT

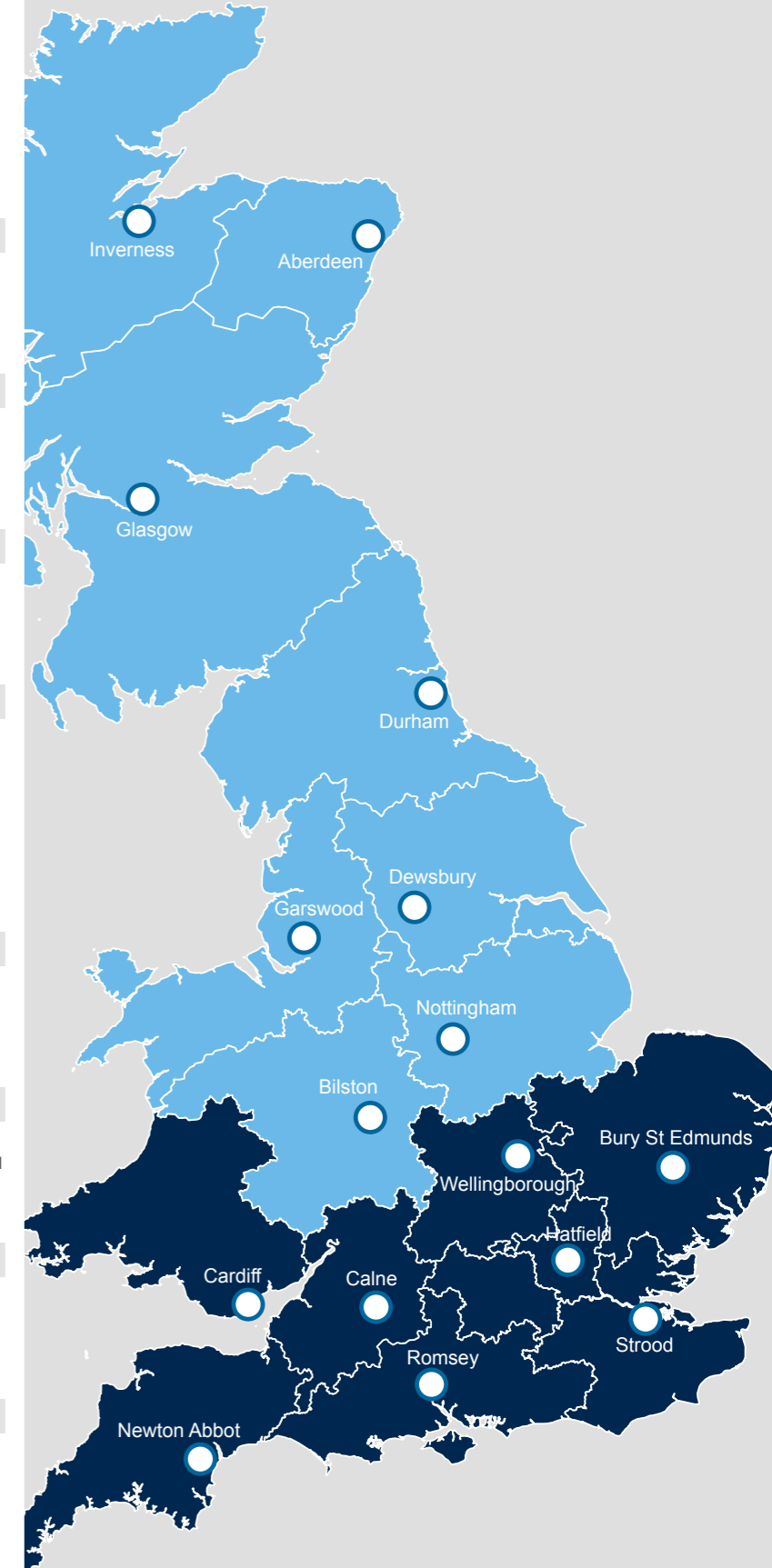

mabeyhire

A PERI COMPANY

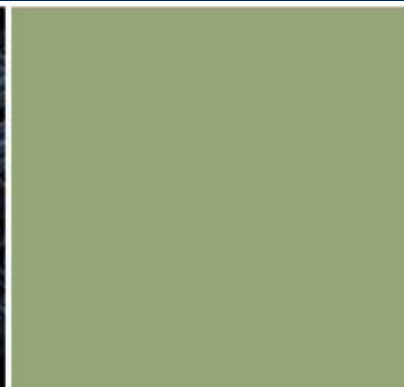

0330 191 3562
action@mabeyhire.co.uk